

BUFFETTEN - SALAD BARS
BUFFETS - BAR À SALADES
BUFFETS - SALAD BARS

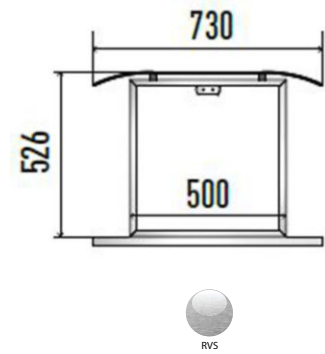

DROP-IN SUPER STRUCTURES

DOGE FISSA CURVO



DOGE ISOLA

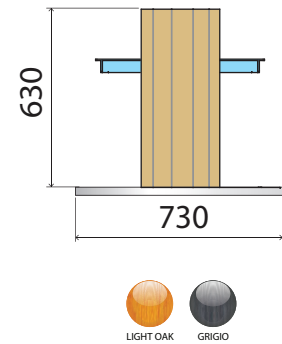

BUFFETTEN - SALAD BARS
BUFFETS - BAR À SALADES
BUFFETS - SALAD BARS



DROP-IN SUPER STRUCTURES

DOGE WALL

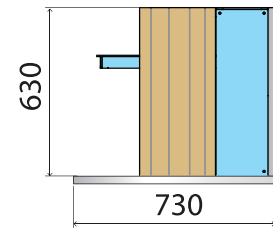

DOGE SERVITO

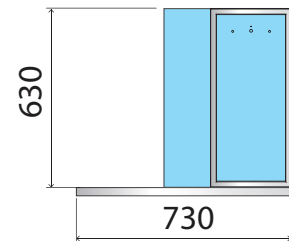

BUFFETTEN - SALAD BARS
BUFFETS - BAR À SALADES
BUFFETS - SALAD BARS



DROP-IN - V / RF - VT

- **Drop-in kits, statisch of geventileerd, voor buffet of selfservice meubel naar keuze.**
 - **Gemakkelijk reinigbare gestampte kuipen (hoek met grote straal in tegenstelling tot gelaste kuipen, HACCP!).**
 - Geïsoleerde RVS kuip voor respectievelijk 3 of 4 of 6 x GN1/1 gastronormen, in draagframe met convectiegaten, maximum diepte: 150 mm.
 - Statisch: serpentineverdamper rond kuip gewikkeld.
 - Geventileerde: kantelbare gecoate verdamper (gasdrukveren), onder kuipbodem.
 - Mogelijke bovenstructuren: zie p. 56 - 57.
- **Kits drop-in, statiques ou ventilés, pour buffet ou meuble self à votre choix.**
 - **Cuves pressées, facilement nettoyables (angle à grand rayon, contrairement aux cuves soudées, HACCP!).**
 - Cuve en inox pour respectivement 3 ou 4 ou 6 x GN1/1 gastronormes, suspendus dans un cadre avec des trous de convection, profondeur maximale: 150 mm.
 - Statiques: évaporateur serpentin enrobé autour de la cuve.
 - Ventilés: évaporateur traité contre la corrosion, relevable à pistons, sous le sol de la cuve.
 - Superstructures possibles: voir p. 56 - 57.
- **Static or ventilated drop-in kits, for buffets or self-service furniture at your choice.**
 - **Easy to clean tanks (pressed, corners with big ray, contrary to the welded tanks , HACCP!).**
 - Insulated stainless steel tank for respectively 3 or 4 or 6 x GN1/1 gastronorms, in a supporting frame with convection holes, maximum depth: 150 mm.
 - Static version: serpentine evaporator bent around the tank.
 - Ventilated version: coated evaporator, easy to tilt (pistons), under the tank.
 - Possible superstructures: see p. 56 - 57.



BASE V RF



BASE V VT



BASE RF



BASE VT

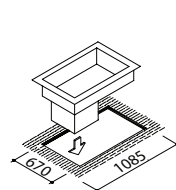

BASE 100

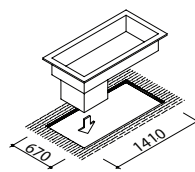

BASE 140

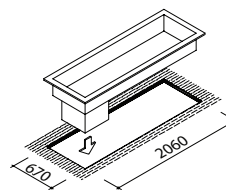

BASE 200

BUFFETTEN - SALAD BARS
BUFFETS - BAR À SALADES
BUFFETS - SALAD BARS



DROP-IN - V / RF - VT

BUFFETTEN / SALAD BARS - BUFFETS / BAR À SALADES - BUFFETS / SALAD BARS : V / RF - VT DROP-IN											
TYPE	STOCK	GN									
ENKEL KUIP - SEULEMENT CUVE - ONLY TANK											
BASE 100	4 WK	3-1/1	39 / 40*	1145 X 730 X 260		1145 X 730 X 330				€ 4.301	€ 2.625
BASE 140	4 WK	4-1/1	47 / 48*	1470 X 730 X 260		1470 X 730 X 330				€ 5.153	€ 2.673
BASE 200	4 WK	6-1/1	55 / 65*	2120 X 730 X 260		2120 X 730 X 330				€ 6.520	€ 3.520
KUIP MET BOVENSTRUCTUUR - CUVE AVEC SUPERSTRUCTURE - TANK WITH SUPERSTRUCTURE											
DOGE FISSA CURVO 100	4 WK	3-1/1	52 / 62*	1142 X 730 X 785		1142 X 730 X 855				€ 4.577	€ 3.445
DOGE FISSA CURVO 140	4 WK	4-1/1	68 / 78*	1470 X 730 X 785		1470 X 730 X 855				€ 5.085	€ 3.668
DOGE FISSA CURVO 200	4 WK	6-1/1	89 / 99*	2120 X 730 X 785		2120 X 730 X 855				€ 5.797	€ 4.387
DOGE ISOLA 100	4 WK	3-1/1	80 / 115*	1142 X 730 X 890		1142 X 730 X 960	10			€ 6.419	€ 4.762
DOGE ISOLA 140	4 WK	4-1/1	98 / 135*	1470 X 730 X 890		1470 X 730 X 960	12			€ 7.208	€ 5.202
DOGE ISOLA 200	4 WK	6-1/1	127 / 127*	2120 X 730 X 890		2120 X 730 X 960	20			€ 7.553	€ 6.156
DOGE WALL 100	4 WK	3-1/1	107 / 117*	1142 X 730 X 890		1145 X 730 X 960	10			€ 7.352	€ 5.787
DOGE WALL 140	4 WK	4-1/1	128 / 138*	1470 X 730 X 890		1470 X 730 X 960	12			€ 8.300	€ 6.370
DOGE WALL 200	4 WK	6-1/1	169 / 169*	2120 X 730 X 890		2120 X 730 X 960	20			€ 8.760	€ 7.539
DOGE SERVITO 100	4 WK	3-1/1	72 / 82*	1142 X 730 X 710		1145 X 730 X 780	10			€ 6.404	€ 4.694
DOGE SERVITO 140	4 WK	4-1/1	88 / 98*	1470 X 730 X 710		1470 X 730 X 780	12			€ 7.249	€ 4.845
DOGE SERVITO 200	4 WK	6-1/1	119 / 119*	2120 X 730 X 710		2120 X 730 X 780	20			€ 7.921	€ 6.156

BUFFETTEN / SALAD BARS - BUFFETS / BAR À SALADES - BUFFETS / SALAD BARS : RF - VT DROP-IN											
TYPE	STOCK	GN									
ENKEL KUIP - SEULEMENT CUVE - ONLY TANK											
BASE 100	4 WK	3-1/1	54 / 86*	1145 X 730 X 660		1145 X 730 X 730	340 / 700*	400 / 600*		€ 5.683	€ 3.785
BASE 140	4 WK	4-1/1	65 / 108*	1470 X 730 X 660		1470 X 730 X 730	380 / 700*	450 / 750*		€ 6.528	€ 3.835
BASE 200	4 WK	6-1/1	88 / 129*	2120 X 730 X 660		2120 X 730 X 730	450 / 740*	520 / 1050*		€ 8.104	€ 4.625
KUIP MET BOVENSTRUCTUUR - CUVE AVEC SUPERSTRUCTURE - TANK WITH SUPERSTRUCTURE											
DOGE FISSA CURVO 100	4 WK	3-1/1	74 / 112*	1142 X 730 X 1185		1142 X 730 X 1255	340 / 710*	400 / 600*		€ 5.868	€ 4.120
DOGE FISSA CURVO 140	4 WK	4-1/1	89 / 120*	1470 X 730 X 1185		1470 X 730 X 1255	380 / 730*	450 / 750*		€ 6.363	€ 4.323
DOGE FISSA CURVO 200	4 WK	6-1/1	119 / 119*	2120 X 730 X 1185		2120 X 730 X 1255	450 / 750*	520 / 1050*		€ 8.094	€ 5.067
DOGE ISOLA 100	4 WK	3-1/1	93 / 131*	1142 X 730 X 1290		1142 X 730 X 1360	410 / 610*	350 / 600*		€ 8.040	€ 5.546
DOGE ISOLA 140	4 WK	4-1/1	119 / 150*	1470 X 730 X 1290		1470 X 730 X 1360	412 / 712*	450 / 750*		€ 8.854	€ 5.993
DOGE ISOLA 200	4 WK	6-1/1	157 / 157*	2120 X 730 X 1290		2120 X 730 X 1360	470 / 850*	550 / 1050*		€ 9.207	€ 6.961
DOGE WALL 100	4 WK	3-1/1	138 / 148*	1142 X 730 X 1290		1142 X 730 X 1360	410 / 610*	400 / 600*		€ 9.130	€ 6.700
DOGE WALL 140	4 WK	4-1/1	156 / 167*	1470 X 730 X 1290		1470 X 730 X 1360	412 / 712*	450 / 750*		€ 10.107	€ 7.290
DOGE WALL 200	4 WK	6-1/1	218	2120 X 730 X 1290		2120 X 730 X 1360	470 / 850*	520 / 1050*		€ 10.437	€ 8.433
DOGE SERVITO 100	4 WK	3-1/1	94 / 104*	1142 X 730 X 1110		1142 X 730 X 1180	410 / 610*	400 / 600*		€ 8.082	€ 5.882
DOGE SERVITO 140	4 WK	4-1/1	109 / 119*	1470 X 730 X 1110		1470 X 730 X 1180	412 / 712*	450 / 750*		€ 8.947	€ 5.890
DOGE SERVITO 200	4 WK	6-1/1	154	2120 X 730 X 1110		2120 X 730 X 1180	470 / 850*	520 / 1050*		€ 10.628	€ 7.167

(*) VT: geventileerd - ventilé - ventilated.

OPTIES - OPTIONS - OPTIONS : VRF - RF		
OPTIE 1	Kuip in RVS - cuve en inox - stainless steel well (Aisi 316)	€ 1.050



RF 100: -20°C - RF 140: -18°C - RF 200: -16°C
RF DOGE 100: -20°C - RF DOGE 140: -18°C - RF DOGE 200: -18°C



RF 100 VT: -18°C - RF 140 VT: -20°C - RF 200 VT: -14°C

BUFFETTEN - SALAD BARS
 BUFFETS - BAR À SALADES
 BUFFETS - SALAD BARS



DROP-IN PRF-BM

- 🇳🇱 • Drop-in kits, plaatkoeling PRF en bain-marie warm-houd BM, voor buffet of selfservice meubel naar keuze.
 - Mogelijke bovenstructuur: Tango, Doge, zie p. 64 - 65.
 - PRF:** Geïsoleerde RVS plaat, respectievelijk 3 of 4 of 6 x GN1/1 maatvoering. Voor tijdelijke presentatie, gekoeld, zoals ochtendbuffetten,...
 - BM:** Volgens beschrijving RF maar weerstandsmat onder kuip i.p.v. verdamper.
- 🇫🇷 • Kits drop-in, froid statique de plaque PRF et bain-marie en maintien au chaud BM, pour buffet ou meuble self à votre choix.
 - Superstructure possible: Tango, Doge, voir p. 64 - 65.
 - PRF:** Plaque en inox pour respectivement dimensions 3 ou 4 ou 6 x GN1/1. Pour une présentation temporaire, réfrigérée, comme des buffets de petits déjeuners,...
 - BM:** Suivant la description du RF mais nappe-résistance sous la cuve au lieu d'un évaporateur.
- 🇬🇧 • Static plate cooling PRF and bain-marie warm-hold drop-in kits BM, for buffets or self-service furniture at your choice.
 - Possible superstructure: Tango, Doge, see p.64 - 65.
 - PRF:** Insulated stainless steel plate with respectively 3 or 4 or 6 x GN1/1 dimensions. For a temporary presentation, chilled, like breakfast buffets,...
 - BM:** Following the RF description but with heater-carpet under the tank instead of an evaporator.



BASE PRF



BASE BM

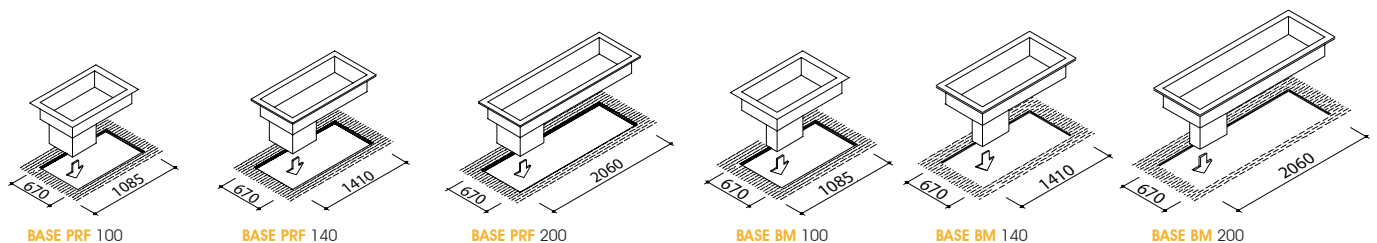

BUFFETTEN - SALAD BARS
BUFFETS - BAR À SALADES
BUFFETS - SALAD BARS



DROP-IN PRF-BM

BUFFETTEN / SALAD BARS - BUFFETS / BAR À SALADES - BUFFETS / SALAD BARS : VPRF DROP-IN									
	TYPE	STOCK	GN					€ EXCL	
ENKEL KUIP SEULEMENT CUVE ONLY TANK	BASE 100	4 WK	3-1/1	28	1145 X 730 X 100			€ 2.892	
	BASE 140	4 WK	4-1/1	38	1470 X 730 X 100			€ 2.942	
	BASE 200	4 WK	6-1/1	46	2120 X 730 X 100			€ 4.390	
KUIP MET BOVENSTRUCTUUR CUVE AVEC SUPERSTRUCTURE TANK WITH SUPERSTRUCTURE	DOGE FISSA CURVO 100	4 WK	3-1/1	50	1142 X 730 X 630			€ 3.433	
	DOGE FISSA CURVO 140	4 WK	4-1/1	66	1470 X 730 X 630			€ 3.686	
	DOGE FISSA CURVO 200	4 WK	6-1/1	96	2120 X 730 X 630			€ 3.865	
	DOGE ISOLA 100	4 WK	3-1/1	72	1142 X 730 X 730	10		€ 4.673	
	DOGE ISOLA 140	4 WK	4-1/1	88	1470 X 730 X 730	12		€ 5.051	
	DOGE ISOLA 200	4 WK	6-1/1	115	2120 X 730 X 730	20		€ 4.822	
	DOGE WALL 100	4 WK	3-1/1	105	1142 X 730 X 730	10		€ 5.456	
	DOGE WALL 140	4 WK	4-1/1	126	1470 X 730 X 730	12		€ 5.944	
	DOGE WALL 200	4 WK	6-1/1	166	2120 X 730 X 730	20		€ 6.802	
	DOGE SERVITO 100	4 WK	3-1/1	70	1142 X 730 X 550	10		€ 4.603	
	DOGE SERVITO 140	4 WK	4-1/1	86	1470 X 730 X 550	12		€ 4.850	
	DOGE SERVITO 200	4 WK	6-1/1	116	2120 X 730 X 550	20		€ 6.115	

BUFFETTEN / SALAD BARS - BUFFETS / BAR À SALADES - BUFFETS / SALAD BARS : PRF DROP-IN									
	TYPE	STOCK	GN					€ EXCL	
ENKEL KUIP SEULEMENT CUVE ONLY TANK	BASE 100	4 WK	3-1/1	43	1145 X 730 X 530	340	380	€ 4.053	
	BASE 140	4 WK	4-1/1	50	1470 X 730 X 530	380	440	€ 4.116	
	BASE 200	4 WK	6-1/1	79	2120 X 730 X 530	450	550	€ 5.017	
KUIP MET BOVENSTRUCTUUR CUVE AVEC SUPERSTRUCTURE TANK WITH SUPERSTRUCTURE	DOGE FISSA CURVO 100	4 WK	3-1/1	70	1142 X 730 X 1030	340	380	€ 4.056	
	DOGE FISSA CURVO 140	4 WK	4-1/1	80	1470 X 730 X 1030	380	440	€ 4.228	
	DOGE FISSA CURVO 200	4 WK	6-1/1	96	2120 X 730 X 1030	450	550	€ 4.557	
	DOGE ISOLA 100	4 WK	3-1/1	88	1142 X 730 X 1160	410	340	€ 5.504	
	DOGE ISOLA 140	4 WK	4-1/1	103	1470 X 730 X 1160	412	440	€ 5.890	
	DOGE ISOLA 200	4 WK	6-1/1	132	2120 X 730 X 1160	470	550	€ 6.919	
	DOGE WALL 100	4 WK	3-1/1	130	1142 X 730 X 1160	410	340	€ 6.343	
	DOGE WALL 140	4 WK	4-1/1	147	1470 X 730 X 1160	412	440	€ 6.864	
	DOGE WALL 200	4 WK	6-1/1	200	2120 X 730 X 1160	470	550	€ 7.750	
	DOGE SERVITO 100	4 WK	3-1/1	90	1142 X 730 X 980	410	340	€ 5.752	
	DOGE SERVITO 140	4 WK	4-1/1	100	1470 X 730 X 980	412	440	€ 6.213	
	DOGE SERVITO 200	4 WK	6-1/1	116	2120 X 730 X 980	470	550	€ 7.401	



PRF 100: -25°C - PRF 140: -20°C - PRF 200: -20°C

PRF DOGE 100: -22°C - PRF DOGE 140: -20°C - PRF DOGE 200: -18°C

BUFFETTEN / SALAD BARS - BUFFETS / BAR À SALADES - BUFFETS / SALAD BARS : BM DROP-IN							
	TYPE	STOCK	GN				€ EXCL
ENKEL KUIP SEULEMENT CUVE ONLY TANK	BASE 100	4 WK	3-1/1	34	1145 X 730 X 350	2000	€ 3.985
	BASE 140	4 WK	4-1/1	43	1470 X 730 X 350	3000	€ 4.011
	BASE 200	4 WK	6-1/1	50	2120 X 730 X 350	4500	€ 5.325
KUIP MET BOVENSTRUCTUUR CUVE AVEC SUPERSTRUCTURE TANK WITH SUPERSTRUCTURE	DOGE ISOLA 100	4 WK	3-1/1	89	1142 X 730 X 980	2240	€ 5.869
	DOGE ISOLA 140	4 WK	4-1/1	96	1470 X 730 X 980	3480	€ 6.439
	DOGE ISOLA 200	4 WK	6-1/1	128	2120 X 730 X 980	5220	€ 7.586
	DOGE WALL 100	4 WK	3-1/1	65	1145 X 730 X 1080	2360	€ 7.820
	DOGE WALL 140	4 WK	4-1/1	80	1470 X 730 X 1080	3480	€ 8.623
	DOGE WALL 200	4 WK	6-1/1	108	2120 X 730 X 1080	5220	€ 10.369
	DOGE SERVITO 100	4 WK	3-1/1	122	1142 X 730 X 980	2240	€ 6.473
	DOGE SERVITO 140	4 WK	4-1/1	134	1470 X 730 X 980	3480	€ 7.036
	DOGE SERVITO 200	4 WK	6-1/1	191	2120 X 730 X 980	5220	€ 8.589



230/1/50 - 140 + 200 : 400/3/50 op vraag - sur demande - on request.

BUFFETTEN - SALAD BARS
 BUFFETS - BAR À SALADES
 BUFFETS - SALAD BARS



MEUBELEN - MEUBLES - FURNITURE

- Mooi eigentijds design en aantrekkelijke presentatie.
- Stevige en robuuste meubelen door gebruik van massief hout en natuursteen i.p.v. kunststof = duurzaamheid.
- Gebruiksgemak door handige hoogte en afdekschermen = ergonomisch.
- Goede, door onafhankelijke organisatie geteste, temperatuurhandhaving en mooi afgeronde, gestampte kuip met grote straal = betere t° , hygiëne en HACCP.
- Beau design contemporain et présentation attrayante.
- Meubles robustes et solides par l'usage de bois massif et de pierre naturelle au lieu de matière synthétique = durabilité.
- Facilité d'emploi par hauteur et pares-haleine pratiques = ergonomique.
- Bon maintien de température, testé par une organisation indépendante et cuve pressée bien arrondie avec grand rayon = meilleures t° , hygiène et HACCP.

- Beautiful contemporary design and attractive presentation.
- Solid and heavy duty appliances since the use of massive wood and natural stone instead of plastics = durability.
- Easy use by a handy height and hygienic shield = ergonomic.
- Good temperature hold, tested by an independent organization and pressed basin, well rounded with a big radius = better t° , hygiene and HACCP.

DOGE ISOLA



DOGE WALL

